

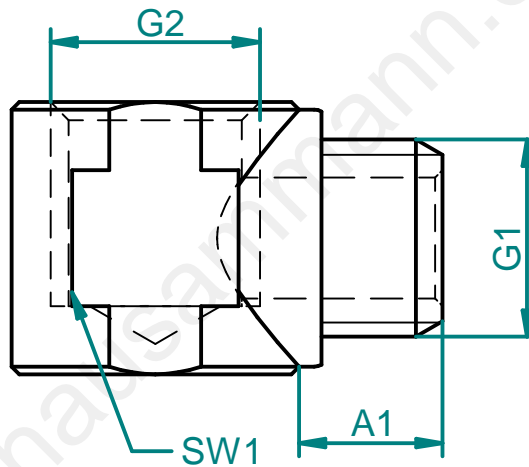

General tolerances ISO 2768-m						Index	Date	Visum	Modification	Index	Date	Visum	Modification
Basic-size	...6	> 6 ...30	> 30 ...120	>120 ...400	> 400 ...1000								
medium	±0.1	±0.2	±0.3	±0.5	±0.8								



Specifications points D,K,H	
D= doc.points	
K= critical	
H= main	

		Material: Messing			
		Scale 2:1			
		 Date plotted 01.09.11		Visum E.Z	
		checked			
		40.682		Solid Edge	
		Format A4		Index 00	
Accord-draw.no.:	Origin-draw.no.:	Replacement for:			
		 HAUSAMMANN KOMponenten PRODUKTION SYSTEME			
© 2010, für dieses Dokument behalten wir uns alle Rechte vor.		© 2 010, Nous nous reservons tous les droits sur ce document		© 2 010, We reserve all rights in connection with this document	